



Submittal Data Sheet

AY-XP12CHU / AE-X12CHU

12,000 BTU Inverter Single Zone Wall Mounted Heat Pump

Job Name:	
Reference:	Date:

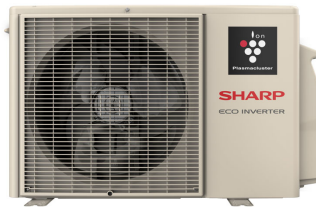

Product Features

- A2L refrigerant R32
- Energy Star Cold Climate certified
- High efficiency operation down to -22°F (-30°C)
- Safe "Hot Gas Pipe" de-icing system
- 50ft long "Coanda Airflow"
- "Multi Space" air circulation
- Built-in Wi-Fi Adapter



Sharp Air app available in Apple® App Store and Google® Play Store.

CAPACITIES and POWER INPUT			
Cooling at 95°F	Max. Capacity	BTU/H	14,000
	Rated Capacity	BTU/H	12,000
	Min. Capacity	BTU/H	3,500
	Max. Power Input	W	960
	Rated Power Input	W	750
	Moisture Removal	Pints/h	1.9
	Sensible Heat Factor	%	84.8
	Power Factor	%	83
Heating at 47°F	Max. Capacity	BTU/H	22,850
	Rated Capacity	BTU/H	16,000
	Min. Capacity	BTU/H	3,100
	Max. Power Input	W	2,100
Heating at 17°F	Max. Capacity	BTU/H	18,900
	Rated Capacity	BTU/H	18,900
	Max. Power Input	W	2,500
	Rated Power Input	W	2,500
Heating at 5°F	Max. Capacity	BTU/H	16,000
	Max. Power Input	W	2,230
Heating at -4°F	Max. Capacity	BTU/H	13,800
Heating at -13°F	Max. Capacity	BTU/H	11,600
Heating at -17°F	Max. Capacity	BTU/H	11,200
Heating at -22°F	Max. Capacity	BTU/H	9,700

NOTE: Test conditions are based on AHRI 210/240.

Cooling at 95°F	Indoor: 80°F (26.7°C) DB / 67°F (19.4°C) WB Outdoor: 95°F (35.0°C) DB / 75°F (23.9°C) WB
Heating at 47°F	Indoor: 70°F (21.1°C) DB / 60°F (15.6°C) WB Outdoor: 47°F (8.3°C) DB / 43°F (6.1°C) WB
Heating at 17°F	Indoor: 70°F (21.1°C) DB / 60°F (15.6°C) WB Outdoor: 17°F (-8.3°C) DB / 15°F (-9.4°C) WB
Heating at 5°F	Indoor: 70°F (21.1°C) DB / 60°F (15.6°C) WB Outdoor: 5°F (-15.0°C) DB / 3°F (-16.1°C) WB
Heating at -4°F	Indoor: 70°F (21.1°C) DB / 60°F (15.6°C) WB Outdoor: -4°F (-20.0°C) DB / -1°F (-1°C) WB
Heating at -13°F	Indoor: 70°F (21.1°C) DB / 60°F (15.6°C) WB Outdoor: -13°F (-25.0°C) DB / -1°F (-1°C) WB
Heating at -17°F	Indoor: 70°F (21.1°C) DB / 60°F (15.6°C) WB Outdoor: -17°F (-27.2°C) DB / -1°F (-1°C) WB
Heating at -22°F	Indoor: 70°F (21.1°C) DB / 60°F (15.6°C) WB Outdoor: -22°F (-30.0°C) DB / -1°F (-1°C) WB

EFFICIENCIES		
SEER/SEER2		25.0 / 25.0
EER2		16.0
HSPF (IV) /HSPF2 (IV)		12.0 / 11.0
HSPF (V) /HSPF2 (V)		9.6 / 9.0
COP at 47F		4.26
COP at 17F at Max. Capacity		2.22
COP at 5F at Max. Capacity		2.1
COP at -22F at Max. Capacity		1.8

ELECTRICAL		
Voltage Phase Frequency		208/230 1 60
Guaranteed Voltage Range	V AC	187 - 253
Voltage: Indoor - Outdoor, S1-S2	V AC	208/230
Voltage: Indoor - Outdoor, S2-S3	V DC	24
Short-circuit Current Rating (SCCR)	KA	5.0
Rated Running Current (Cool/Heat)	A	4.0 / 5.8
MCA (Indoor/Outdoor)	A	0.4/15.0
Maximum Fuse Size (MOCP)	A	20
Circuit Breaker	A	15
Wire Size (Indoor - Outdoor)	AWG	14

COMPRESSOR		
Type		Single Rotary
Model	A	KTN150D63UFZR3
Rated Load Amps	A	10.5
Oil Type		Ester Oil VG75r
Oil Charge	oz (ml)	14.2 (420)

PIPING		
Gas Pipe Size O.D. (Flared)	In. (mm)	3/8 (9.52)
Liquid Pipe Size O.D. (Flared)	In. (mm)	1/4 (6.35)
Chargeless Piping Length	Ft. (m)	25 (7.6)
Min.-Max Pipe Length	Ft. (m)	10 (3) - 66 (20)
Maximum Height Difference	Ft. (m)	33 (10)

REFRIGERANT		
Type		R32
Refrigerant Control		Expansion Valve
Charge	oz. (g)	36 (1020)
Additional Charge of Refrigerant	oz./Ft. (g/m)	0.16 (15)
Defrost Method		Reverse Cycle
De-icing System		Hot Gas Pipe

FAN and SOUND		Indoor Unit	Outdoor Unit
Fan		Cross Flow Fan	Propeller Fan
Fan Motor Full Load Amperage	A	0.4	0.7
Fan Motor Output	W	30	41
Airflow Rate at Cooling, Dry	CFM	597 / 519 / 403 / 290 / 212	
Airflow Rate at Cooling, Wet	CFM	557 / 484 / 376 / 270 / 198	1013
Airflow Rate at Heating, Dry	CFM	636 / 558 / 466 / 374 / 212	
Sound Pressure Level (Cooling)	dB(A)	43 / 40 / 36 / 28 / 24	49
Sound Pressure Level (Heating)	dB(A)	44 / 40 / 35 / 29 / 22	50

DIMENSION and WEIGHT		Indoor Unit	Outdoor Unit
Unit Dimensions	W x H x D: In. (mm)	41.4 x 12.4x 9.8 (1052 x 316 x 249)	30.7 x21.3x 10.6 (780 x 540 x 269)
Package Dimensions	W x H x D: In. (mm)	43.8 x 12.7 x 15.3 (1113 x 323 x 389)	36.3 x 23.8 x 15.5 (922 x 603 x 393)
Unit Weight	lbs. (kg)	31 (14)	67 (30)
Package Weight	lbs. (kg)	35 (16)	73 (33)

OPERATING TEMPERATURE		Indoor Unit	Outdoor Unit
Cooling (Max. / Min.)	°F (°C)	90 / 70 (32.2 / 21.1)	115 / 14 (46.1 / -10)
Cooling Thermal Lock-out / Re-start Temperatures	°F (°C)	-	-
Heating (Max. / Min.)	°F (°C)	81 / - (27.2 / -)	75 / -22 (23.9 / -30)
Heating Thermal Lock-out / Re-start Temperatures	°F (°C)	-	-22 (-30)

OTHERS		Indoor Unit	Outdoor Unit
Drain Pipe Size	In. (mm)	-	φ0.67 and φ0.79 (φ17 and φ20)
External Finish Color		Premium White	Warm Beige
Coating on Heat Exchanger		Normal Coating	Blue Fin Coating

NOTE: Test conditions are based on AHRI 210/240.

DIMENSIONS: AY-XP12CHU / AE-X12CHU

Indoor Unit

Length unit: inch (mm)

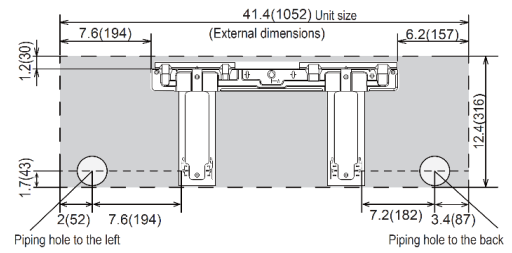
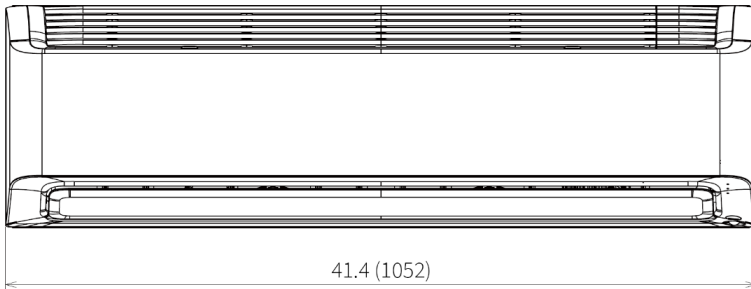
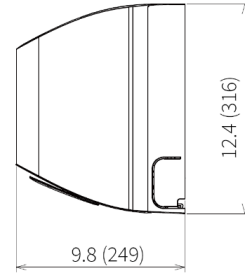

Outdoor Unit

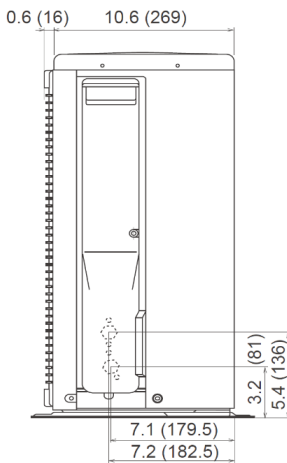
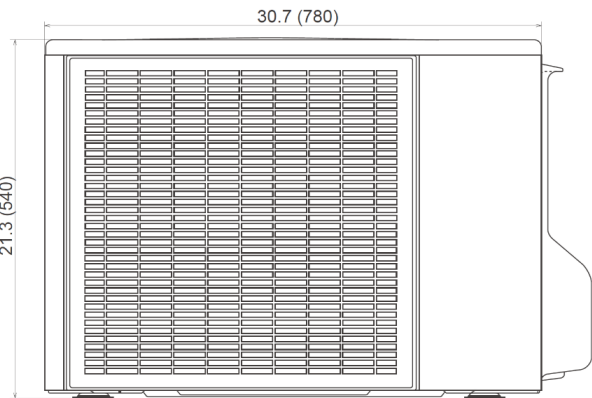
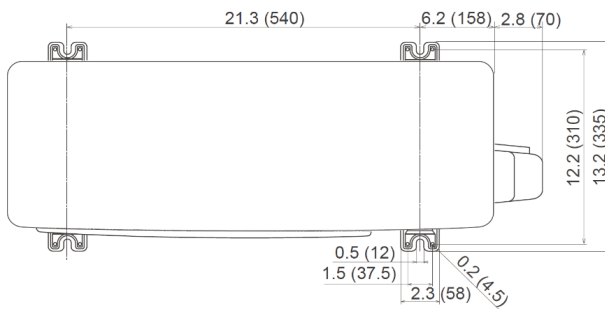

Required Space

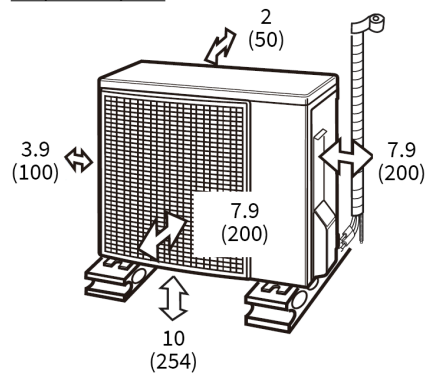

SHARP

Sharp Corporation, Japan
2-1-25, Kyutaromachi, Chuo-ku, Osaka
541-8522

